

Effect of Heating Light on Lamps to the Behaviour of Tilapia Seedlings Sourced from Solar Panels

I Gede Suputra Widharma¹, I Gde Nyoman Sangka¹, I Nengah Sunaya¹, I Made Sajayasa¹,
I Ketut Darminta¹ and A. A. M. Dewi Anggreni²

¹Electrical Department, Bali State Polytechnic, Bukit Jimbaran, Badung, Bali, Indonesia

²Faculty of Agricultural Technology, Udayana University, Badung, Bali, Indonesia

Keywords: Heating Light, Halogen Lamp, Tilapia Seedlings, Solar Panels.

Abstract: Fish like many living organisms have specific tolerant range of various environmental parameters, thus fish larvae ponds of specific types of fish species requires certain conditions that have to be reach. People that work in the fish larvae ponds have to be engaged in all day activities to maintain the living fish larvae habitat. One important parameter for fish larvae ponds is temperature. Larvae that have hatched should be raise in a special place. Stocking density for maintenance of 50-100 larvae/m². To avoid the cold weather occurs, warming can be do with halogen lamps. Solar Energy is produced by the Sunlight is a non-vanishing renewable source of energy which is free from ecofriendly. The highest intensity of sunlight occurs at 11.00-14.00 with the value of the intensity of sunlight is 90100-112500 lumens. Based on condition and calculation, the fish larvae pond need 4 solar panels, 2 batteries, and 4 halogen lamps. Monitoring and taking actions to maintain the habitat's sustainable environment to certain larvae inside of ponds. Halogen lamps give the warmth to the water with the intensity of the light in cash about 1.2°C increase every minutes. It is using a thermostat to keep the water temperature as needed by the fish larvae about 27°C until 30°C all night.

1 INTRODUCTION

Electrical energy is now increasingly depleted, for that we must use electrical energy efficiently. In the world, especially in Indonesia, the government has suggested that people can save electricity. Today, many experts have discovered a variety of electric power generation equipment. One of the optimal tools in Indonesia is the Solar Panel. Solar panels work to convert sunlight energy into electrical energy. Solar Panel is a device consisting of solar cells, batteries charger and batteries that convert light into electricity. Solar panels produce direct current or DC. To use household appliances that have alternating current or AC, a converter (a DC to AC current converter) is needed. (Wisely, 1982). If solar panels are developed in Indonesia, which has the advantage of getting sunshine all year round, and in remote areas that are difficult to reach by power station is very suitable. (Roy, 1981)

Solar panels are also an environmentally friendly alternative energy. If 1 unit of solar cells is for

electricity during the day and 1 unit is for storing electricity at night, of course we can save quite a lot of electricity. (Sayigh, 1999)

This stored electrical energy can be used for lighting at night and provide heat to the water like a fish larvae ponds. (Zhu, 1998). The fish larvae that have hatched, should be raised in a special place. Transplants are carried out after the larvae are 5-7 days old. Larvae rearing tanks can be in the form of walls, aquariums, plastic containers. (Fuller, 1998). Stocking density for the maintenance of 50-200 larvae/m², depending on the type of tub. Give high protein feed in the form of fine flour measuring 0.2-0.5 mm. Frequency of feeding 4-5 times a day, each time as much as 1 teaspoon of flour-shaped feed. The larval nursery duration ranges from 3-4 weeks, or until fish larvae measure 2-3 cm. (Ayles, 1981).

Larvae that have reached this size must be immediately moved to the next nursery tank. Because the capacity of the larvae is no longer feasible for such a large fish. The problem is if within 3-4 weeks the cold weather occurs, the fish larvae will be die. (Plaia,

 <https://orcid.org/0000-0002-7090-545X>

1985). Thus the artificial warmers needed to warm the water in winter. Warming can be done with heating element or lamp. In this research will be examined heating with lights, because it has a dual effect besides warming water, it also functions for lighting. (Little, 1992). The bright tub will be a trap like an insect that will be eaten by fish. One of the sources of heat and light will be obtained from halogen lamps which will be the part of this research besides using solar cells (PLTS) as a renewable energy source. (Duffie, 1991)

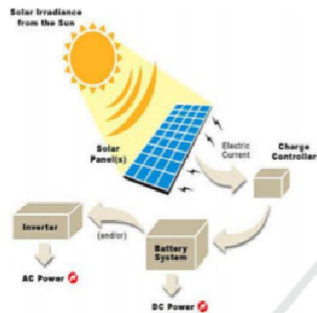

Figure 1: Standing alone PLTS system.

Problems that arise are what is the effect of lighting with halogen lamps to regulate water temperature like fish larvae? How solar cells (PLTS) as an energy source can supply power for halogen lamps. (Suputra, 2020).

2 MANUSCRIPT PREPARATION

This research is quantitative research. The main concept of this research is to help fish farmers in increasing their productivity by utilizing solar light through solar power plants and halogen lighting. This research uses halogen lamps lighting process for larvae in fish ponds with solar cells. PLTS system is shown in Figure 1 convert light from the sun become electric energy. PLTS system consist of solar cell, charge controller, batteries system, and inverter.

Solar cells receive solar radiation in one day varies greatly. This is because sunlight has a greater intensity when it is daytime compared to the morning. To find out the capacity of the generated power, measurements are made of current (I) and voltage (V) on the arrangement of solar cells called modules.

2.1 Variable Operational Definitions

The main component that builds PLTS is solar

module, which functions as a transformer of sunlight energy into electrical energy. This component converts energy from sunlight into electrical energy. Solar cells are vital components that are generally made of semiconductor materials. Multi crystal line silicon is the most widely used material in the solar cell industry. Multi crystalline and mono crystalline silicon produce relatively higher efficiency than amorphous silicon. While amorphous silicon is used because of the relatively lower cost. As one measure of solar cell performance is efficiency, namely the percentage change of sunlight energy into electrical energy. The efficiency of solar cells that now produced varies greatly.

Mono crystalline silicon has an efficiency of 12~15%. Multi crystal line silicon has an efficiency of 10~13%. Amorphous silicon has an efficiency of 6-9%. With the discovery of a new method, the efficiency of multi crystalline silicon can reach 16.0% while mono crystalline can reach more than 17%. (Abdelhad, 2017). From the curve in Figure 2, known: I_0 is the short circuit current, V is the open circuit voltage, and MPP is the maximum power point. PMPP, VMPP, and IMPP are the power, voltage and current at the maximum power point, respectively. (Duffie, 1991).

Table 1: The parameter of photovoltaic module.

Typical electrical parameters for PV modules		
Parameter	Unit	Value
Peak power (WP)	W	100
Power output tolerance	W	0 - 3
Module efficiency	%	14.57
Open circuit voltage (V)	V	21.6
Max. power point voltage	V	17.2
Short circuit current (I_0)	A	6.2
Max. power point current (I_{mp})	A	5.81
Max power temperature coef.	% °C ⁻¹	-0.406
Short circuit temperature coef.	% °C ⁻¹	+0.057
Open circuit voltage coefficient	% °C ⁻¹	-0.308
Weight	kg	9

The use of halogen lamps is standardized as the main lighting. Of course the light produced by halogen lamps is brighter and more durable than ordinary lamps. Halogen lamps are included in the type of incandescent lamps. The temperature is the driving factor of all processes that happen in the fish larvae pond. It's not only affecting the development and growth of the plants and other animals in the pond, but also regulates the oxygen level in the water. The optimal temperature for tropical fish larvae is 27°C with allowed deviations of 2°C.

Another important factor is further development

of the system in terms of adding new sensors that will improve the fish production and quality (Suputra Widharma et al., 2020) Every change in the water level, either raising or lowering, it affects in a great manner the finishes in the pond and causes suitable reaction from them. To control all sides of fish larvae pond, halogen lamps put in each corner of pond. Energy from halogen lamps will be increase the water temperature in the night, to keep the water in the fish larvae pond still warm and comfort for the fish larvae condition.

2.2 Tested of System

The factor of the operation of solar cells in order to obtain a very maximum value depending on ambient air temperature, solar radiation, wind speed blowing, the earth atmosphere (cloudy, air dust, air vapor, fogging), orientation of the panels, and the position of solar cells to the sun. This section must be in one column. The equipment needed are solar cells 100 WP, thermostat temperature gauge, lux meter, 40W halogen lamps, solar charge controller MPPT, battery 12V 100Ah, connecting cable, protection panel box, voltage measurement tool, and some waste bottles to keep the lamp from water in the fish larvae pond.

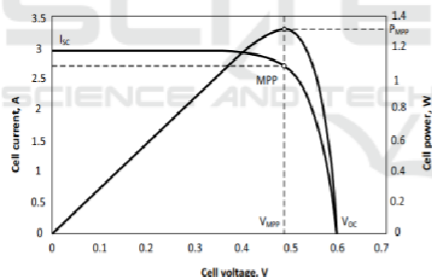

Figure 2: I-V and P-V characteristics curve for a PV panel.

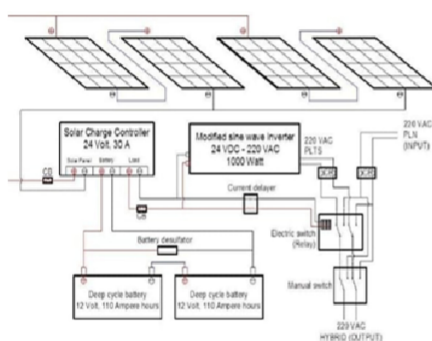

Figure 3: Schema of solar cell to the halogen lamps.

2.3 Data Analysis

Data obtained from the test results are processed quantitatively. To obtain the value of the electric parameters result by the value of the test voltage, current, and power. The average value is all parameter results are summed, then divided by the amount of data. Explanation of the research flow: firstly is start doing research that is preparing the equipment and installing the research equipment, after the equipment is installed at the solar cell temperature starting from the temperature condition, if the temperature setting has not been reached then the temperature setting can be re-done, then analyzing the data obtained from measurement results. Comparing with the growth and development of larvae in the pond. Solar panels, convert solar energy into electricity. Solar cell has illuminated by the sun, making photons that produce electric current. Then electric current will flow through the line to another. The factor of the operation of solar cells in order to obtain maximum value depend on some factors.

2.3.1 Ambient Air Temperature

Solar cells can operate optimally if the cell temperature remains normal (at 25°C). The temperature rise is higher than the normal temperature in the cell decrease the voltage value.

2.3.2 Solar Radiation

Solar radiation on earth and various locations varies, and depends on circumstances solar spectrum to earth. Solar insolation will have a lot of effect on current (I) little bit on voltage (V).

2.3.3 Wind Speed Blowing

Wind speed around the location of the solar cell array can help cool down surface temperature of solar cell array glasses.

2.3.4 The State of the Earth's Atmosphere

The atmosphere of the earth is types of particles of air dust, cloud, smoke, air vapor (Rh), fog and pollution largely determine the maximum electric current yield from a row of solar cells.

2.3.5 The Orientation of the Panels or Solar Cell Array

The optimum orientation of the solar cell series (array) towards the sun is important that the panels of

solar cells can produce maximum energy. Besides the direction orientation, the tilt angle of the panel solar cells is also very influential maximum energy yield.

Maintain sunlight from falling onto a solar cell panel surface perpendicular will get a maximum energy. If cannot maintain the perpendicularity between the sunlight and the cell plane solar, then the extra area of the solar cell panel is needed.

Figure 4 shows that the panels put on the roof one meter above the land with angle about 20°. Solar charge controller and battery are stand under it. The solar charge controller, used to adjust batteries charging settings, to keep the battery from being overloaded and under-charged. The battery functions as a storage of electrical energy that will be fill by electricity coming from the solar cell system. At the time of discharge of charge, the direct current from the battery will be convert into alternating current by the inverter and then flow to the load.



Figure 4: Solar panel used to energy source.

Halogen lamps with using reusing bottles in the fish larvae pond to make the water warm. Using waste bottle of milk and mineral water to cover the lamp from water.

2.4 Results and Discussion

This problem justify that the power of material is depend on voltage and current. The value of material power according to Power Law is voltage time current as equation below.

$$P = V \times I \quad (1)$$

$$P = \sum P_o / 12 \quad (2)$$

Power (P, watt) is voltage (V, volt) times current (I, ampere). Power (P, watt) is also sum of each measurement divide by twelve.

I-V readings through the panels were monitored by four digital multi meter under varying load

resistances applied by two load resistors to have detailed information about PV panel power output. Figure 5 shows that schematics of PV module measurement system. The voltage of solar cells output measure by using voltage measurement tools every hour, then continue to determine its power.

Solving the problem justify that the power of halogen lamp is keep the temperature of water in the fish larvae pond. Energy (W, joule) is power (P, watt) every time (t, second). It need to determine how many the halogen lamps increase the water temperature after the light temperature meet the water condition.

The energy is from lamps is equal to volume of water (mass) and temperature change. So, both of equation below used to know the temperature change every minutes.

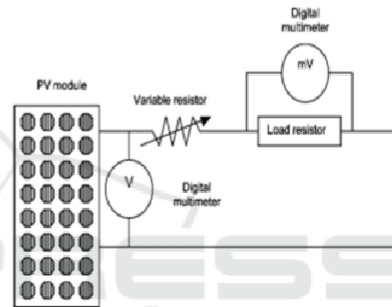

Figure 5: Schematic of PV module measurement system.

Equation (3) is use to find the energy of halogen lamps every second. Equation (4) is use to find the temperature change after the energy meet the volume of water. (Hunt, 1982).

$$W = P \times t \quad (3)$$

$$W = m \cdot c \cdot \Delta T \quad (4)$$

2.4.1 Results

Result of daily average measurements of daylight intensity are shown in the following table. From the table shows in the afternoon around 11.00 until 14.00 intensity the average high sun is around 90,100 up to 112,500 lumens. When the sky clear, solar intensity can be maximum. But the solar intensity can be minimum when the weather has not supported at a day the sun was covered by clouds. (Provenzano, 1987). Table 2 is recorded based on the value of solar intensity then the solar panel will change the intensity become voltage and current.

Table 2: Average intensity and power.

Time	Intensity (lumen)	Power (watt)
07.00	37,900	217.6
08.00	50,100	156.8
09.00	61,100	192.0
10.00	73,800	173.6
11.00	90,100	161.2
12.00	100,300	156.0
13.00	112,500	150.8
14.00	96,800	150.8
15.00	80,700	145.6
16.00	56,500	145.6
17.00	40,600	162.4
18.00	30,000	156.8

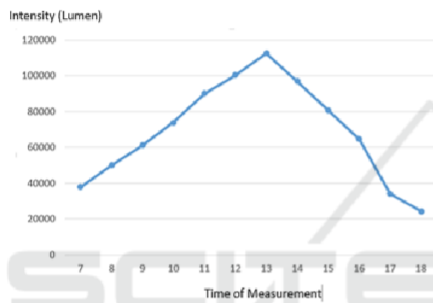

Figure 6: Curve of polar panel intensity average.

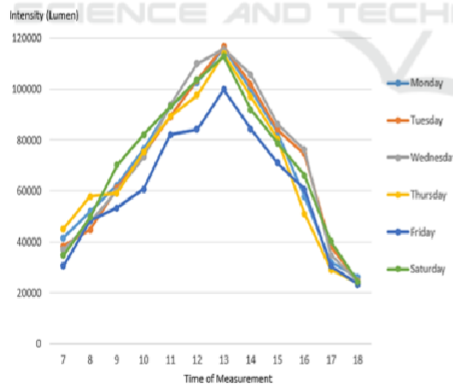

Figure 7: Curve of polar panel intensity average.

The shape of the average intensity of the sun in a week is determined with ratio the totally of solar intensity in a week by six [Figure 6] and intensity of solar in a week is various depend on the weather of day [Figure 7], then power generated is based on the

intensity of the sun as shown the calculated voltage and current recorded

2.4.2 Discussion

This research is a step to combine power of halogen lamp and temperature of fish larvae pond. After knows how the solar cells can charge the battery along day, then continue to determine how the halogen lamp can keep temperature of the fish larvae ponds constant warm, it's about 27° until 30° C.

With volume of pond is 4 m x 4 m x 0.5 m water depth obtain mass (m) is about 8 kg. The halogen lamp power is 40 W and active every second. Then all of these parameters used in (2) and (3) to find the temperature changed.

$$\begin{aligned}
 W &= P \cdot t \\
 W &= 40 \cdot 1 \\
 &= 40 \text{ J (every second)} \\
 &= 2400 \text{ J (every minutes)}
 \end{aligned}$$

This research used four halogen lamps in the fish larvae pond, so that the energy will be produce four times every minutes.

$$\begin{aligned}
 W &= 2400 \times 4 \\
 &= 9600 \text{ J (every minutes)}
 \end{aligned}$$

Then based on this result to get how many temperature increase every minute.

$$\begin{aligned}
 W &= m \cdot c \cdot \Delta T \\
 \Delta T &= W / (m \cdot c) \\
 &= 9600 / (8 \times 1000) \\
 &= 1.2^\circ \text{ C (increases every minutes)}
 \end{aligned}$$

The fish larvae that have hatched, should be raised in a special place. Halogen lamps can increase water temperature in the fish larvae pond about 1.2° C (every minutes), and related with the black principle on the state fluid, if the cold water (the weather at the night factor) meet the warm water from lamps will make the equal temperature of water between them in the fish larvae pond. (Cho, 1998).

The water temperature will be always change every second. The water temperature that close to the lamps will be higher than far away from lamps. This factor make larvae fish more interesting stay near the lamp at around midnight to the morning (Table 3).

When the bright day, the sun makes water temperature in the pond is warm with the temperature more than 27° even more than 30° C. After night, the water temperature will be decrease until under 27°. The lamp will light on and make the water temperature increase again. Thermostat controls the

temperature constant around 27° until 30° C all night by control the lamp to light on or off.

Table 3: Comparison of measurement period time with water temperature in ponds and tilapia seedlings condition.

No	Time	Temperature (° C)	Fish condition
1	19.00	27.5	Spread
2	20.00	27.5	Spread
3	21.00	27.7	Spread and near lamps
4	22.00	28.2	Spread and near lamps
5	23.00	28.3	Near lamps
6	24.00	28.6	Near lamps
7	01.00	28.4	Near lamps
8	02.00	28.2	Near lamps
9	03.00	28.0	Spread and near lamps
10	04.00	28.0	Spread and near lamps
12	05.00	28.2	Spread and near lamps
13	06.00	28.4	Spread
14	07.00	29.5	Spread

Water Temperature is about 27.5° C at 7 pm after the lamp was light on. Tilapia seedlings is spread in a long side pond. From measurement at every hours, the temperature is constant around the lamp. It made tilapia seedlings move to near the lamps to get warm temperature. Based on black principles, calories have been out is equal to calories have been come. The temperature is always constant relatively around the lamps.

3 CONCLUSIONS

Larvae that have hatched, should be raised in a special place. Stocking density for maintenance of 50-100 larvac/m². To avoid the cold weather occurs, warming can be done with halogen lamps. Solar Energy is produced by the Sunlight is a non-vanishing renewable source of energy which is free from friendly. The highest intensity of sunlight occurs at 11.00-14.00 o'clock with the value of the intensity of sunlight is 96000 lumen-112500 lumen. Based on condition and calculation, the research needs 4 solar panels, 2 batteries, and 4 halogen lamps. Halogen lamps give the warmth to the water with the intensity of the light in cash about 1.2° C (increase every minutes), using a thermostat to keep the water temperature as needed by the fish larvae about around 27° until 30° C all night. Tilapia seedlings behavior is stay near the lamps to get warm condition.

ACKNOWLEDGEMENTS

This research is supported by P3M PNB with the grant of DIPA and all of facilities, students in the automation and electrical engineering. Also dedicated to Lotus 21, Karang Asem, JGK, G3 production, PT. Global International Service (GIS Bali) with startup Jago Servis, electrical lectures, e-Riders community, and fish farmers group where the research result installed and applied.

REFERENCES

- Sayigh A. (1999). *Renewable energy—the way forward*, Applied Energy, 64:15–30
- Wisely, B., Holliday, J.E. and MacDonald, R.E. (1982). *Heating an aquaculture pond with a solar blanket*. Aquaculture, 26, 385-387.
- Zhu, S., Deltour, J. and Wang, S. (1998). *Modeling the thermal characteristics of greenhouse pond systems*. Aquacultural Engineering, 18, 3, 201-217.
- Roy, G.G. and Miller, S.G. (1981). *Data Handbook for Australian Solar Energy Designers*. Research Report No. 7, School of Architecture, University of Western Australia.
- Plaia, W.C. and Willis, S.A. (1985). *A flat-plate solar collector system for use in aquaculture*. The Progressive Fish-Culturist, 47, 2, 129-132.
- Fuller, R.J., Gooley, G. and Guthrie, K. (1998). *Modelling of a low cost solar heating system for warm water aquaculture*. Proc. of Solar '98. Annual Conference of the Australian and New Zealand Solar Energy Society, Christchurch, New Zealand, Nov. 1998.
- Little, M.A. (1992). *Water temperature simulation and validation in a solar heated aquaculture pond*. Ph.D Thesis, Univ of Maryland, USA.
- Duffie, J. A. and Beckman W. A. (1991). *Solar Engineering of Thermal Processes*. 2nd Edition, Wiley-Interscience Publication, New York.
- Suputra Widharma, IG., IN Sunaya, IM Sajayasa, IGN Sangka. (2020). *Building PLTS as Energy Sources for Heating Fish Pond of Tilapia Seedlings*. Vastuwidya, 3, 38-44.
- Ayles, G.B., Scott, K.R., Barica, J. and Lark, J.G.I. (1981). *Combination of a solar collector with water recirculation units in a fish culture operation*. Proc. World Symp. on Aquaculture in Heated Effluents and Recirculation Systems, Stavanger, 28-30 May, Vol 1, Berlin.
- S. Abdelhady, M. S. Abd-Elhady, M. M. Fouad. (2017). *An Understanding of The Operation of Silicon Photovoltaic Panels*. Egy. Energy Procedia, 113, 466 – 475.
- V. D. Hunt. (1982). *Solar Energy Dictionary*. Industrial, New York.

- Provenzano, A.J. and Winfield, J.G. (1987). *Performance of a recirculated fish production system stocked with tilapia hybrids*. *Aqua cultural Engineering*, 6, 15-26.
- Cho, C.Y. and Bureau, D.P. (1998). *Development of bioenergetic models and the Fish-PrFEQ software to estimate production, feeding ration and waste output in aquaculture*. *Aquat Living Resour.*, 11, 4, 199-210.
- J. A. Duffie and W. A. Beckman. (1991). *Solar Energy Thermal Processes*. Wiley, New York.

